



LAND CRUISER 250 DSTC SYSTEM CAMERA & LICENSE PLATE RELOCATION



PLEASE READ ENTIRE GUIDE BEFORE INSTALLATION

Recommended that you read this entire install guide before installation. Check that all hardware is present before starting or scheduling an install. This guide is supplemental to mechanical knowledge and ability. Anyone not familiar with automotive installation should seek professional installation.

IMPORTANT INFO/FAQ

INSTALLATION HELP

Please review terms and conditions for details

Recommended purchaser review Welcome Guide at time of purchase for details

Care & Maintenance and Install Guides available at www.exp-one.com/resources

We do our best to offer timely assistance with your installation questions however as most of our team members are primarily engaged in the manufacturing process and packaging processes, we do not currently offer a tech for on-demand calls and inquiries. For the more technical installs or installs that are time-sensitive in nature, we would recommend our customers seek out the services of professional shops with experience specific to aftermarket bumpers.. We are happy to make recommendations to you on shops familiar with our products in your area. We do our best to respond to installation questions within 24-48 hours of contact as much as possible. Long-distance problem assessment can be difficult, so photos and videos are often required for us to best assist you. We highly recommend your initial contact regarding installation questions include both close-up and full photos, detailed descriptions using our part descriptions as much as possible, and video. This enables us to better assist without having the ability to see the install difficulties directly and assist you as quickly as possible.

NOTE

Expedition One does not guarantee fitment with other aftermarket products, or reinstallation of take off OEM parts.

Expedition One is NOT RESPONSIBLE for damage to paint or powder coating, items assembled in error during installation or costs associated with install, and injury.

OEM manufacture model refreshes/updates, factory build location and suppliers may cause variations in fitment or installation and can not be verified, vehicle to vehicle .

EXAMPLES

The illustrations, diagrams, and examples shown in this guide are provided for reference purposes only. Actual installations may vary depending on model, configuration,, or product updates. Drawings, visuals, and component layouts may differ from what is shown, but the installation principles and procedures remain the same.

EXPEDITION ONE
113 N. 700 W. BUILDING 5C BAY 1
OGDEN, UT 84404
INFO@EXPEDITIONONE.BIZ
801-627-2921 MON-FRI 0900-1700 MST

INSTALL LEVEL



1 STAR ★

EASY - No tools required

2 STARS ★★

BASIC - Requires standard tools, basic mechanical knowledge and understanding

3 STARS ★★★

MODERATE - Requires standard tools. Some drilling and/or cutting.

4 STARS ★★★★

ADVANCED - Requires speciality tools. Drilling, cutting, and grinding required

5 STARS ★★★★★

EXPERT - Professional installation recommended.

We always recommend professional assistance when installing our vehicle products. Always follow safety precautions including the use of safety gear and devices.

IMPORTANT INFO/FAQ

AFTERMARKET or OEM PRODUCTS

We DO NOT guarantee fitment or installation of any aftermarket, third party or OEM parts, accessories, or hardware. This includes items such as lighting, winches, skids, lifts, suspension, and accessory mounts. Access to all brands, manufactures and country of origin specific parts is limited or impossible during the product development stage and subsequent new or modified revisions of said products including OEM design changes or refreshes. It is recommended you have the product in hand and installed before modifying with other aftermarket parts. Consult other sources to gain any first hand knowledge of other products others have installed.

HARDWARE

Please review for details and installation. Figures or data may vary. Leave all accessible hardware loose for installation and tighten all hardware after everything is installed on the vehicle. Check and tighten all hardware after the first 100 miles and/or after off roading.

Some hardware locations do not require being tightened to spec due to there design, location or material attachment (including rubber, plastic, and aluminum). Over tightening may break or damage parts. Torque spec may vary, amounts listed are generic.

HARDWARE		TORQUE SPEC	
SIZE	SOCKET	GR5 / 8.8	GR8 / 10.9
#8	1/4"	X	
#10	5/16"		
1/4"	7/16"	6-8	9-10
5/16"	1/2"	13-14	18-20
3/8"	9/16"	23-26	33-37
7/16"	5/8"	37-41	52-58
1/2"	3/4"	57-64	80-90
M6	10MM	9-10	13-15
M8	13MM	22-24	32-35
M10	15MM	44-49	64-72



GRADE 5



CLASS 8.8

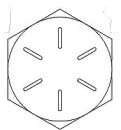



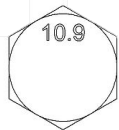











GRADE 8



CLASS 10.9

NOTE

Extra hardware may be left over due to model or option specific items that may not be required for the install. OEM hardware may vary in style or socket size from shown.

TYPES OF HARDWARE		
		
HEX CAP BOLT	WASHER	NYLOC NUT
		
BUTTON HEAD BOLT	FENDER WASHER	HEX NUT
		
CARRIAGE BOLT	INTERNAL TOOTH	JAM NUT
		
SOCKET CAP BOLT	CLIP NUT	ACORN NUT
		
FLAT HEAD SCREW	RIVET NUT	COUPLING

TIGHTEN ALL HARDWARE AFTER EVERYTHING IS INSTALLED ON THE VEHICLE.CHECK REGULARLY

HARDWARE

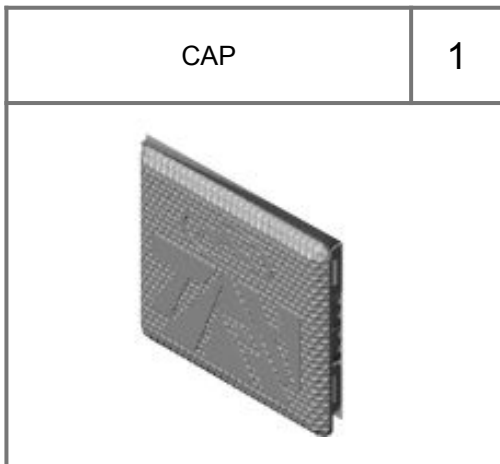
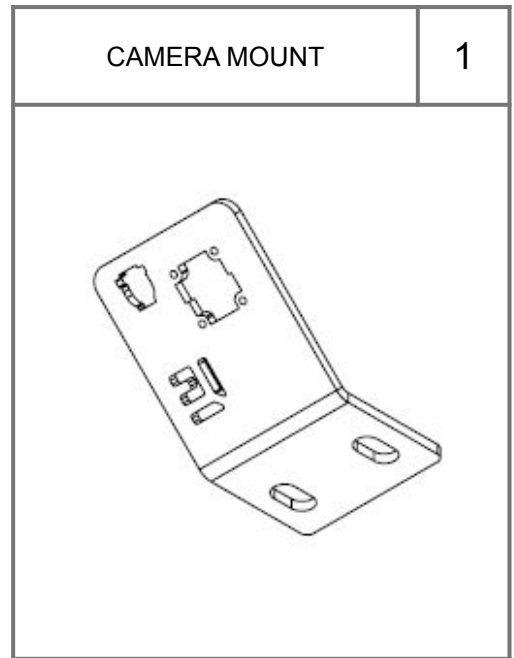
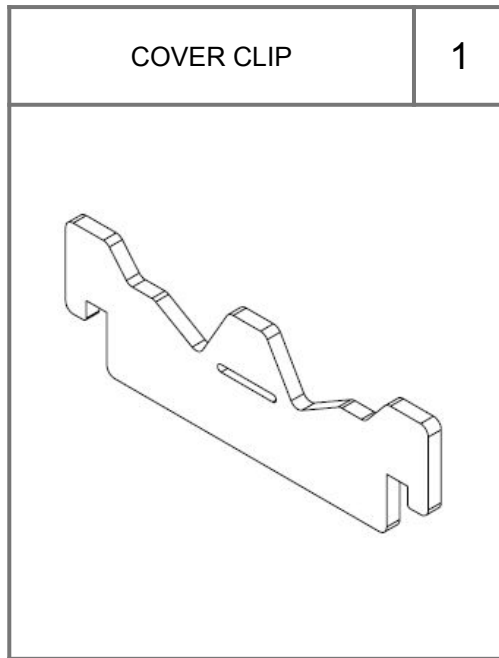
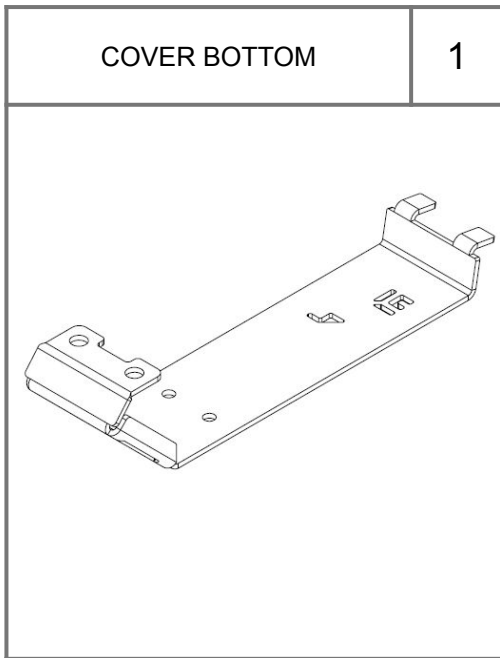
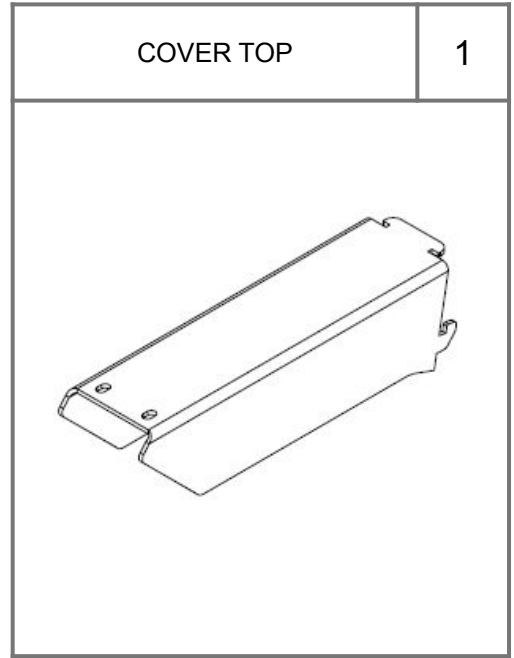
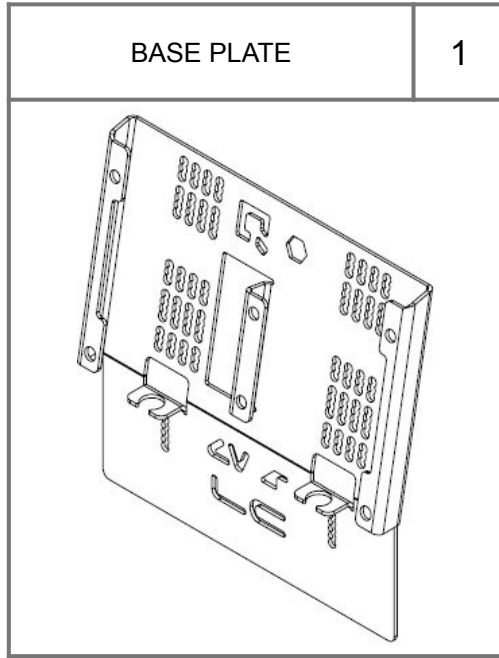
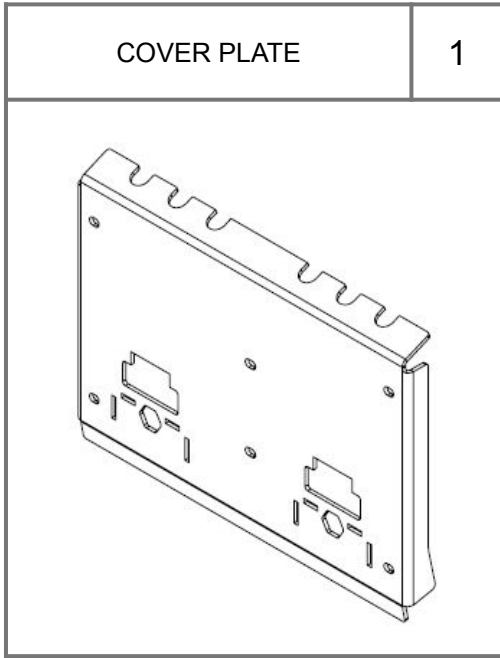

RECOMMENDED TOOLS

- Plenty of high abrasion resistant (recommended) electrical tape
- Basic hand tools (screwdrivers, pliers, wire cutters, razor blade)
- Plastic or Upholstery pry tools
- Wiring/Splicing tools

HARDWARE

1/4" – 20 X 1/2" BUTTON HEADS	2
1/4" – 20 X 1" BUTTON HEADS	12
1/4" - 20 X 1 1/4" HEX CAP BOLT	2
1/4" – 20 CLIP NUTS	8
1/4" – 20 RIVET NUT	2
1/4" – 20 NYLOC NUT	6
1/4" WASHER	8
M6 x 1.0 - 25 HEX CAP BOLT	2
ALUMINUM SPACERS	12
LIGHT & WIRE SET	1
MALE CONNECTORS	4
FEMALE CONNECTORS	4
SPLICE CONNECTORS	2
BLACK WIRE LOOM COVER	1
WIRE SLEEVING	1
COMMS WIRE (EASY ONLY)	1
EXTENDED WIRE HARNESS	1
WIRE CLAMP BLOCK	1
LARGE AND SMALL ZIP TIE	1 EA

!!! ATTENTION !!!

DECISION REQUIRED

EXTENSION OF CAMERA WIRING

EASY - SPLICE METHOD

EASIEST EXECUTION / HIGH RISK OF FAILURE / POTENTIALLY SHORTEST INSTALL TIME

Requires removing only the door panel and limited hardware. Splicing and extending a high count fiber wire, with no guarantees of working and potentially shorting the vehicles screen.

PAGE 7 - 8 & 20 - 24

NOTE

Some vehicles appear to contain an older style harness. If you have the connections shown here. The Splice method is the correct choice



DIFFICULT - EXTENSION CABLE METHOD

COMPLEX AND TEDIOUS / HIGH SUCCESS AND OPERATION / LONGEST INSTALL TIME

Requires the removal of the entire door wire loom. Reconfiguring the loom with an extension harness and reassembly. Complete reinstallation of harness and oem parts.

PAGE 9 - 24

WE HIGHLY RECOMMEND THE EXTENSION CABLE METHOD.



NOTE - Tabs, Plugs, Connectors, and Hardware will be REUSED AND REINSTALLED. Mark key locations on the rear door and their corresponding location on the harness or assembly BEFORE removing so you can reinstall in the same location. DO NOT break or damage any if possible for reinstallation. It is also helpful to document and take pictures of the wiring harness, back door, and plugs as you go for reference as you reinstall.

EASY - SPLICE METHOD

1 – REAR DOOR PANEL REMOVAL

Pry the rear door panel handle and liftgate buttons (disconnect the plug) from the panel. Check for and remove any other visible screws or clips. Begin to carefully pry the main panel and window surrounds away from the door using your plastic trim tool. It is held in place by clips around the edges, so work your way around the panel, prying gently. Save all parts and hardware for reinstallation



COMPLETED RESULT



2 – CAMERA LOCATION ACCESS

Disconnect the wire tabs and any electrical connections from the window latch assembly. Unbolt and remove the assembly from the door.

WARNING
ALL OEM WIRING CLIPS, CLAMPS, OR TABS
WILL BE REUSED. DO NOT DAMAGE

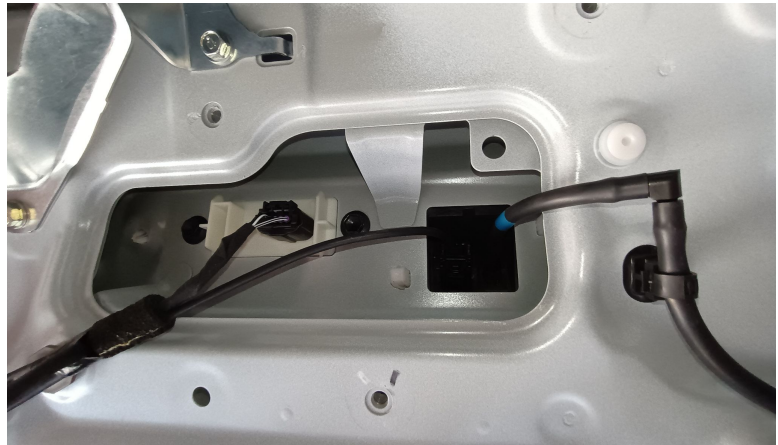
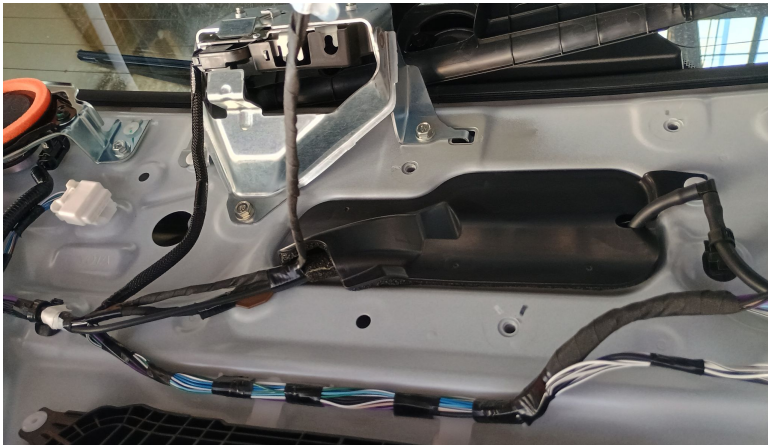
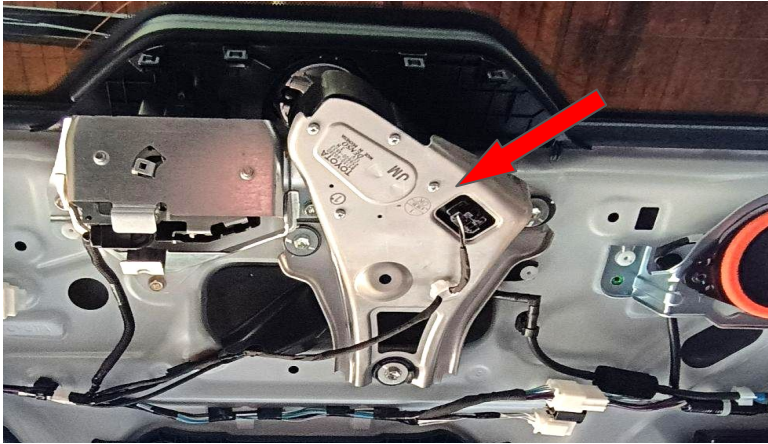

3 – CAMERA AND WASHER REMOVAL

Unplug the camera and remove the two small Torx screws that secure the camera to its mounting housing, remove from the door for relocation later. Disconnect the washer hose at this time, plug hose or empty the fluid to avoid contamination in the work area. Unplug the remaining nearby connections for more access.

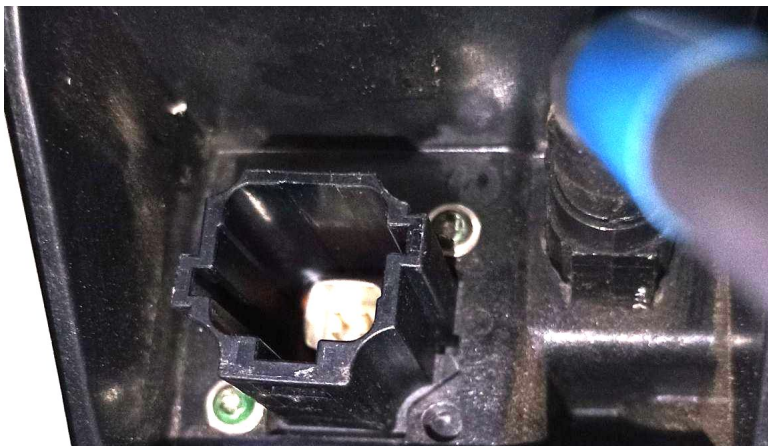

4 – SPLICE THE WIRE

Splice the camera wire to reach the new mount. **Skip to step 10 to resume the install.**

DIFFICULT - EXTENSION CABLE METHOD

1 – REAR DOOR PANEL REMOVAL

Pry the rear door panel handle and liftgate buttons (disconnect the plug) from the panel. Check for and remove any other visible screws or clips. Begin to carefully pry the main panel and window surrounds away from the door using your plastic trim tool. It is held in place by clips around the edges, so work your way around the panel, prying gently. Save all parts and hardware for reinstallation



COMPLETED RESULT

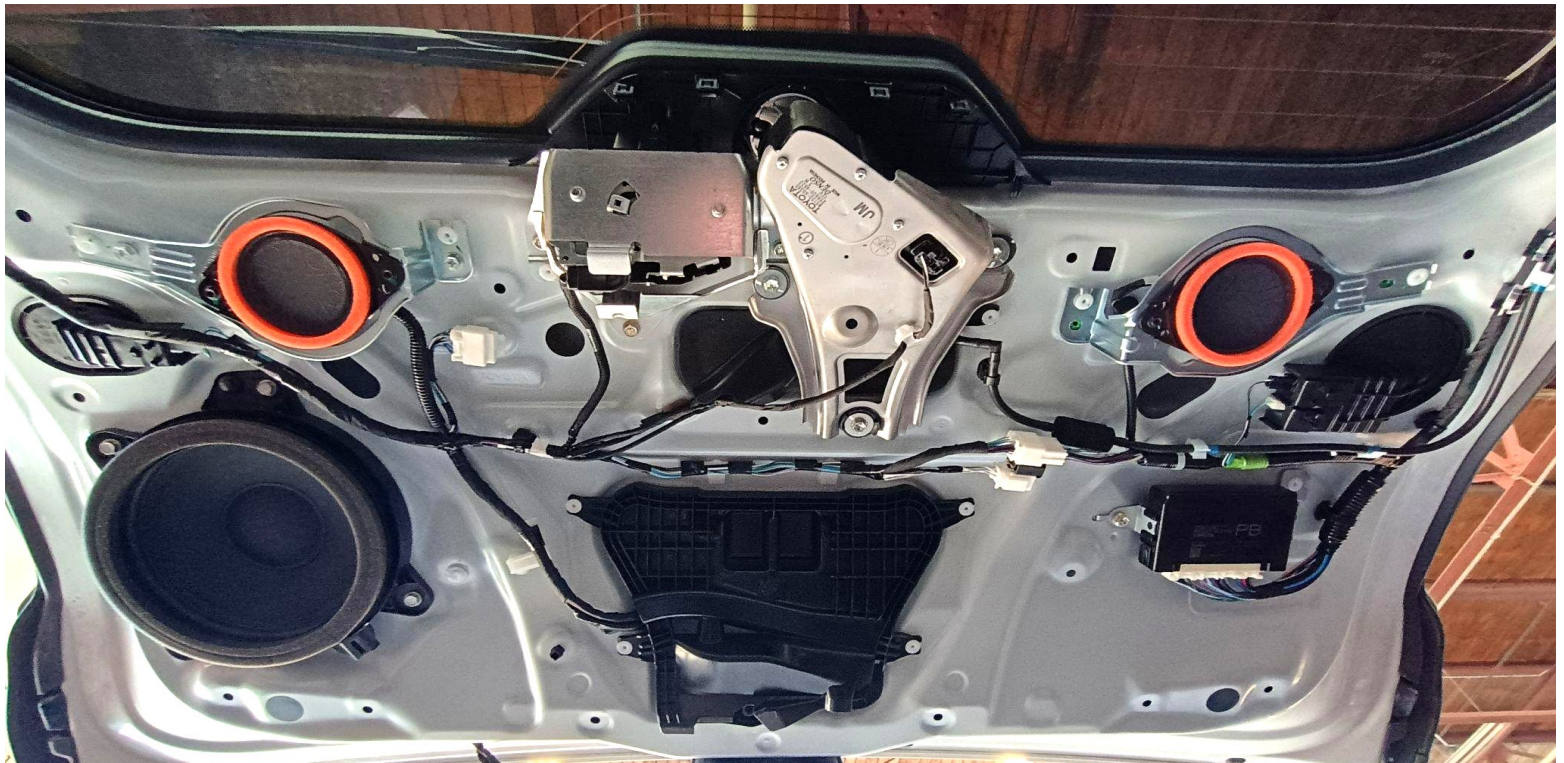

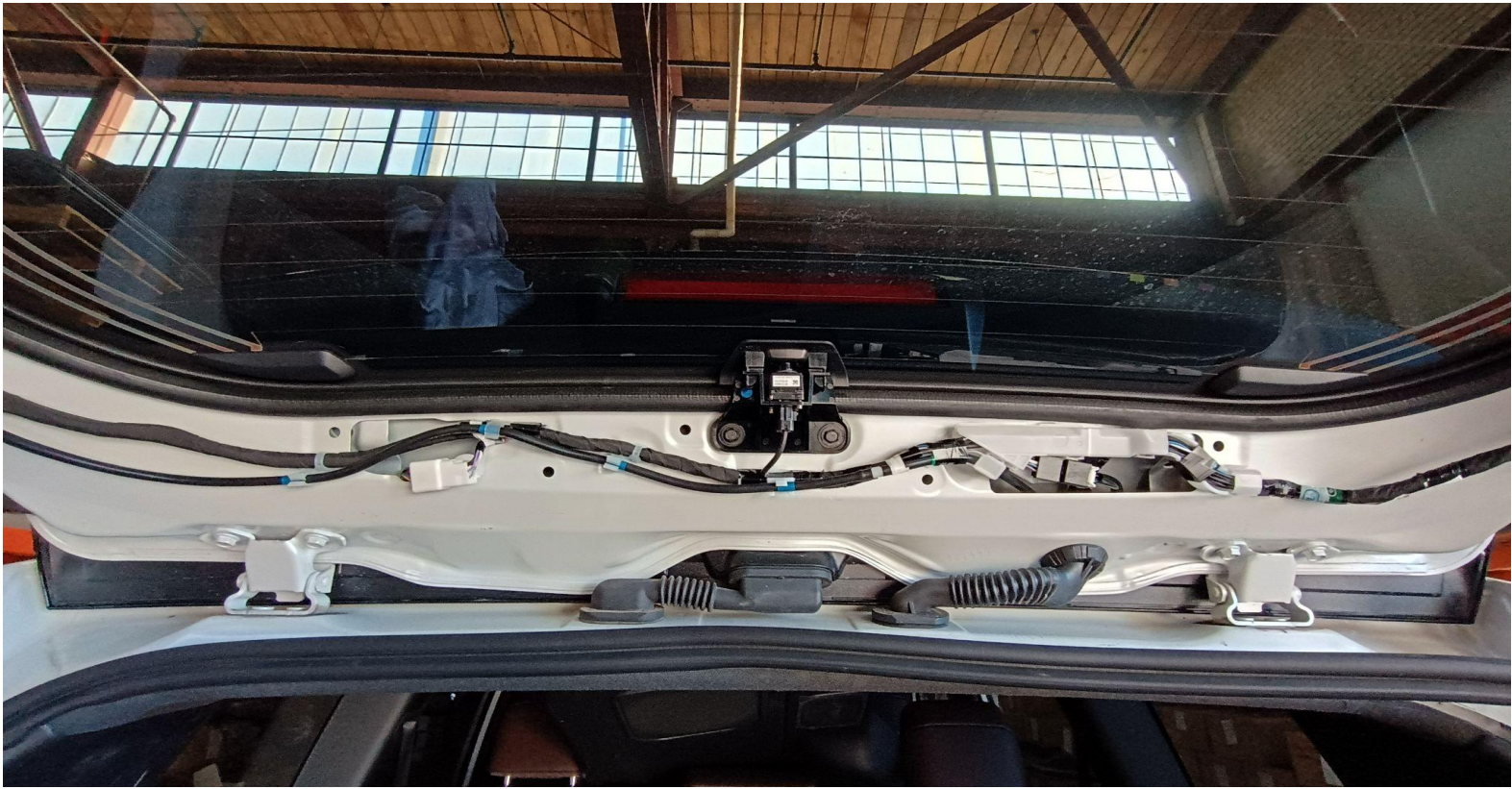

2 – DOOR OPENING AND PANEL

Undo the upper portion of the weather stripping from the opening. Pry and unbolt the passenger side panel. Pull any clips and harness connections in this location. Partially drop the back half of the rear headliner. You do not need to drop the entire headliner, just the back edge clips to be able to get the cable out.

WARNING

ALL OEM WIRING CLIPS, CLAMPS, OR TABS WILL BE REUSED. DO NOT DAMAGE

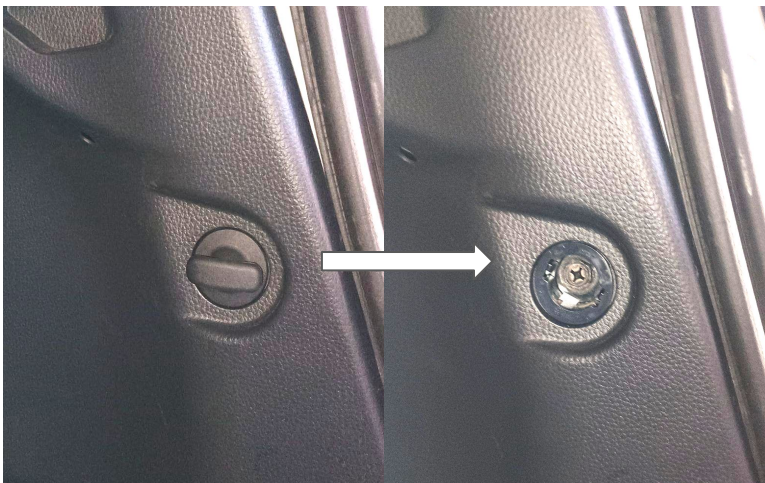

CONTINUED



3 – BODY SIDE LOOM REMOVAL

Disconnect the plug and hose connections in the center of the headliner. With both center and side panel locations free, remove the harness and through the harness pass-through holes in the body and in the rear door.

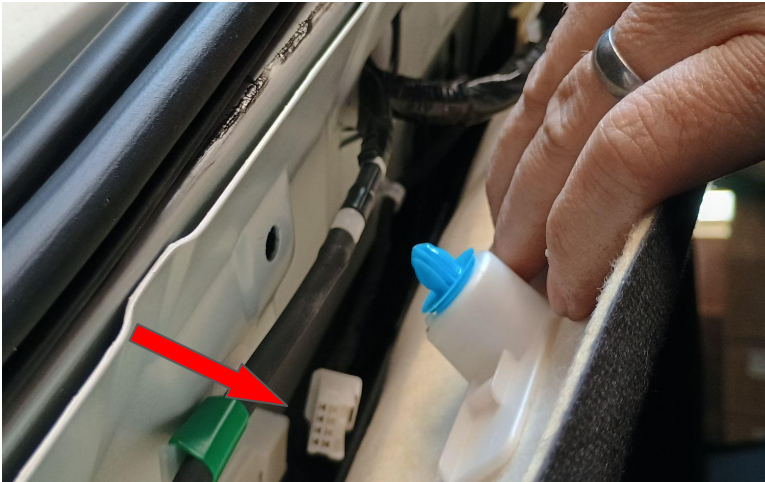



4 – CAMERA LOCATION ACCESS

Disconnect the wire tabs and any electrical connections from the window latch assembly.

Unbolt and remove the assembly from the door.

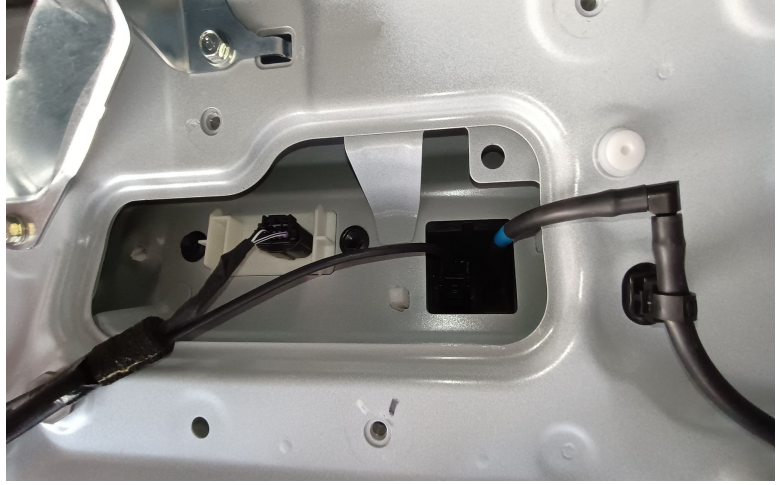
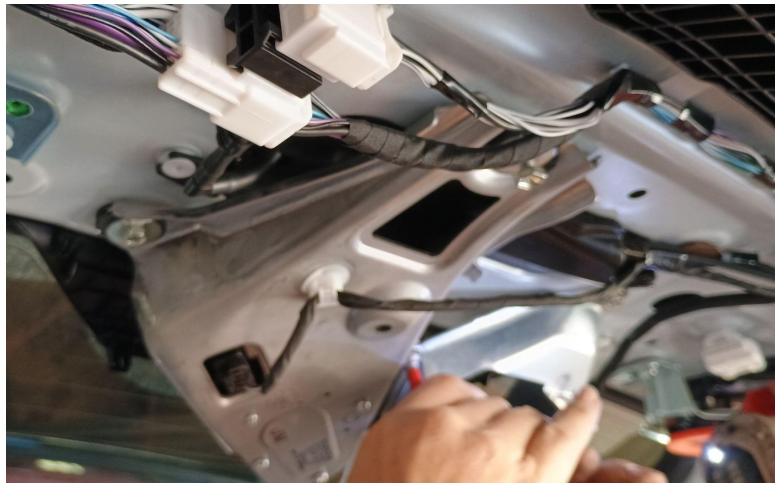
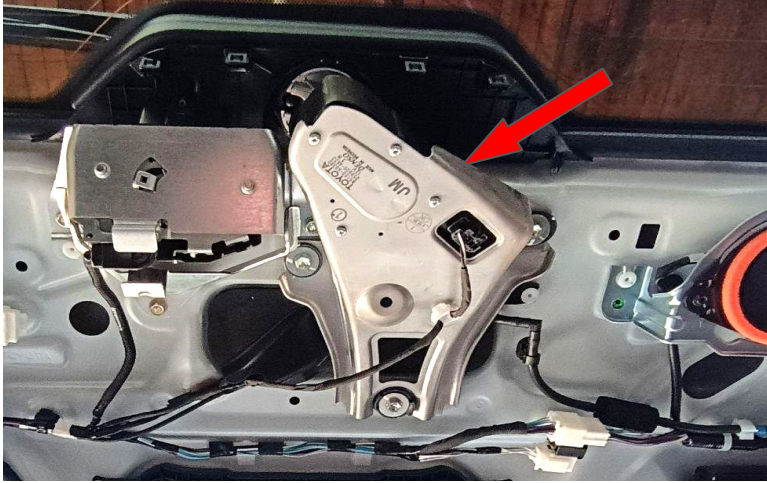

5 – CAMERA AND WASHER REMOVAL

Unplug the camera and remove the two small Torx screws that secure the camera to its mounting housing, remove from the door for relocation later. Disconnect the washer hose at this time, plug hose or empty the fluid to avoid contamination in the work area. Unplug the remaining nearby connections for more access.



6 – DOOR LOOM REMOVAL

Remove the entire wire loom from the rear door. Tabs, Plugs, Connectors, and Hardware will be REUSED AND REINSTALLED. Mark key locations on the rear door and their corresponding location on the harness or assembly BEFORE removing so you can reinstall in the same location. Document and take pictures for reference. Other items may need to be removed to access connectors or tabs.

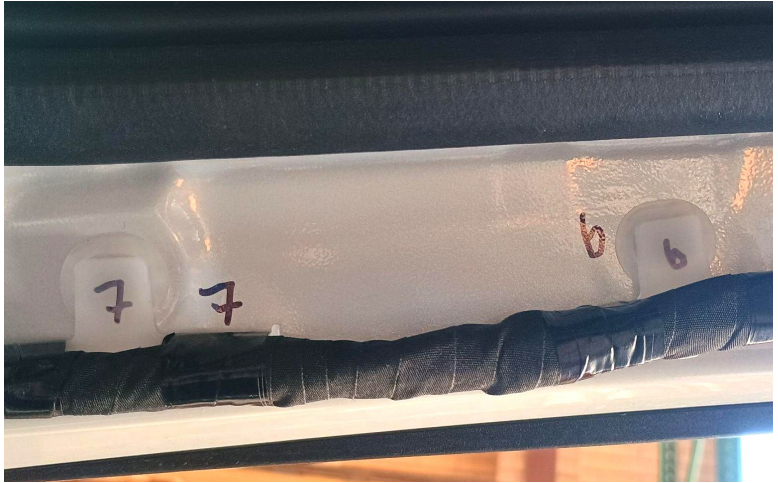
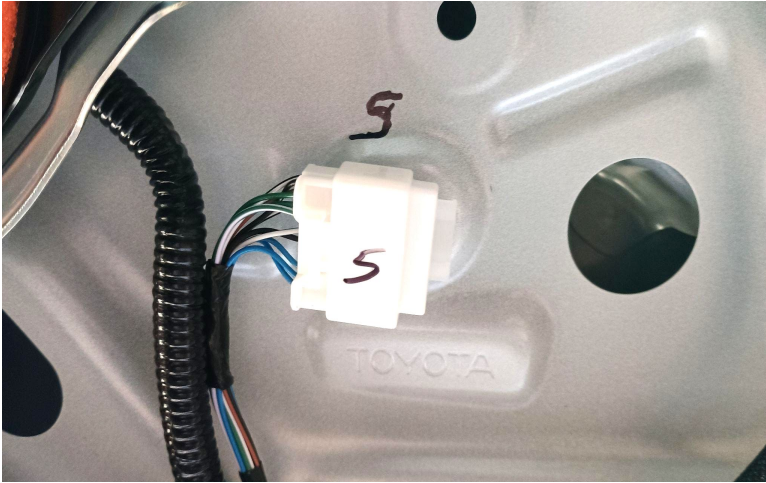

OVERVIEW

The new extension cable will be added to the loom of the current harness.

Position the new cable in place through the boot and close to the original cables location. Next the loom will be undone in increments to pull the original cable down and the new one into place retaping as to go to keep to keep other original locations and parts



BODY SIDE

DOOR SIDE

NEW CABLE

OLD CABLE

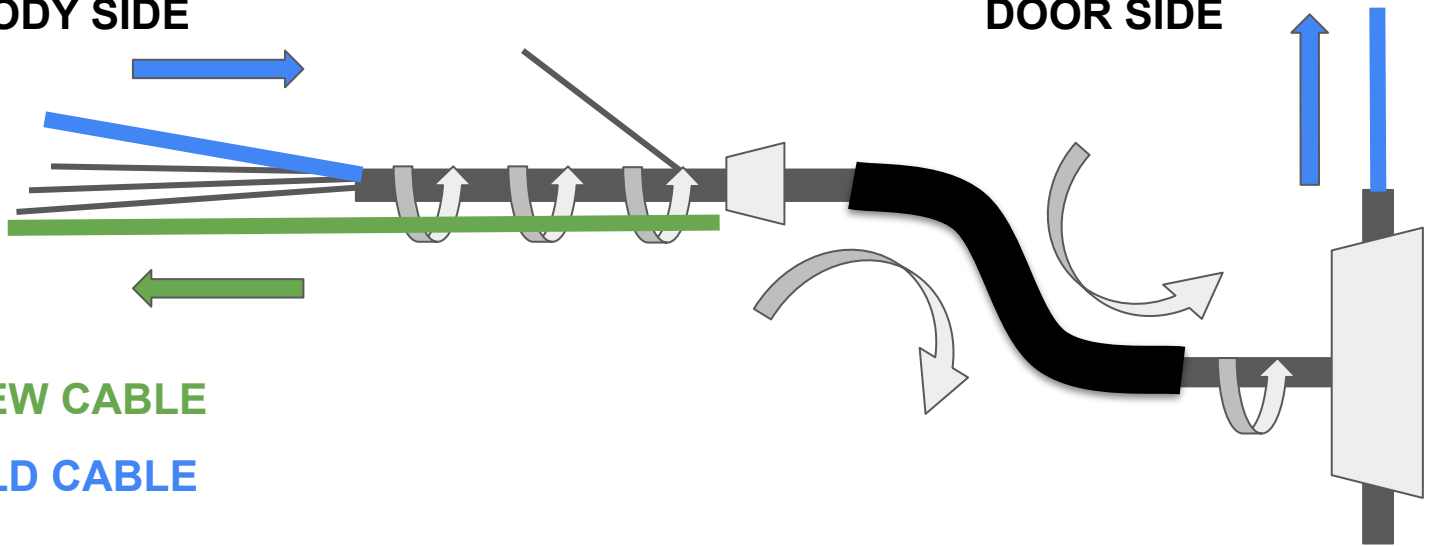

7 - NEW CABLE INSTALLATION

Tape a zip tie to the plug of the new wire with electrical tape and fish the new cable through the boot. Do NOT yank on the cable if it gets snagged so you don't pull the ends off, **pull gently**. You can use a lubricant to get it through the boot if needed- a little window cleaner, soapy water, or **non oil based** cleaner can be helpful. Once both cables are through the tailgate boot, you can fish the camera washer fluid hose back through the tailgate boot using the same method, with a tapped on zip tie

The replacement cable is long enough that you can add as much as 4 inches of length on the upper end without it causing an issue, this means it doesn't necessarily have to be in the exact same spot. However you don't want it to be shorter or further down the harness because it will be harder to plug in when you finish. Add length, do not subtract.



8 - RELOOMING

Continue the process of unwinding and re-taping the loom maintaining the position of all the oem plugs, wire junctions, and harness locating clips. Once you have finished re-taping the loom, you should have approx 3+ feet of the new cable coming out the end of there-taped loom that will be your camera wire

WARNING

DO NOT CUT ANY WIRES IN THE LOOM - RECOMMENDED UN-LOOM BY HAND
ALL OEM WIRING CLIPS, CLAMPS, OR TABS
WILL BE REUSED. DO NOT DAMAGE
REINSTALL IN THE SAME LOCATIONS

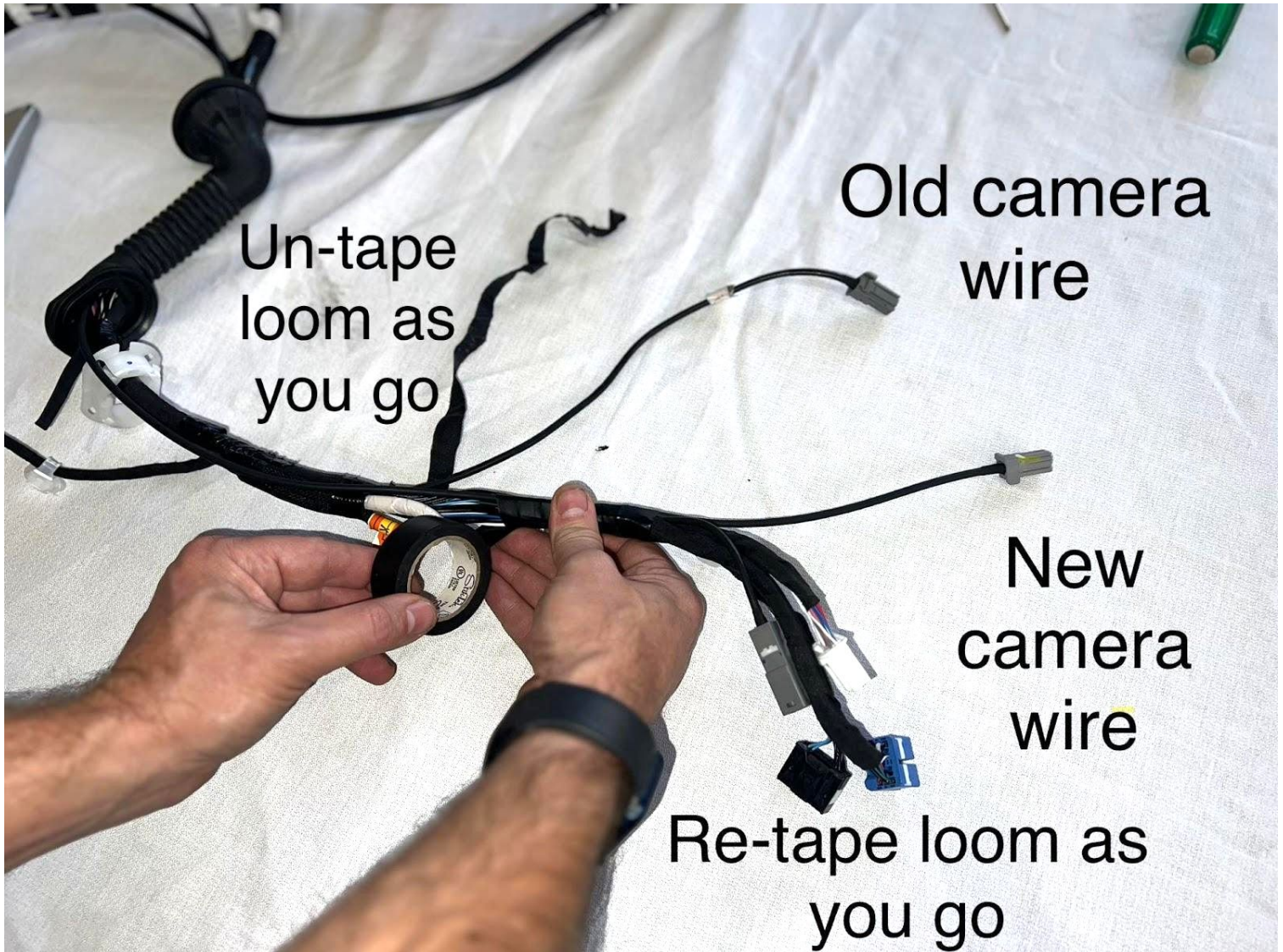

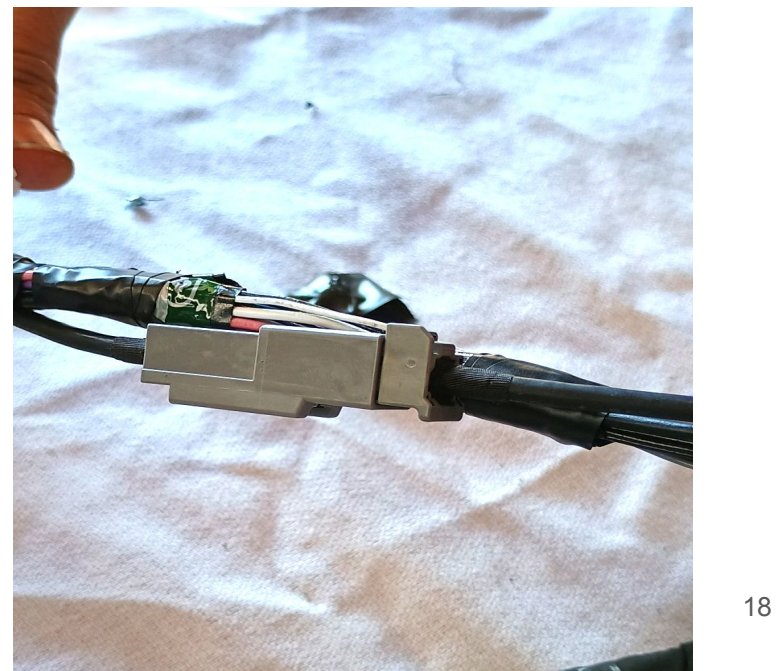
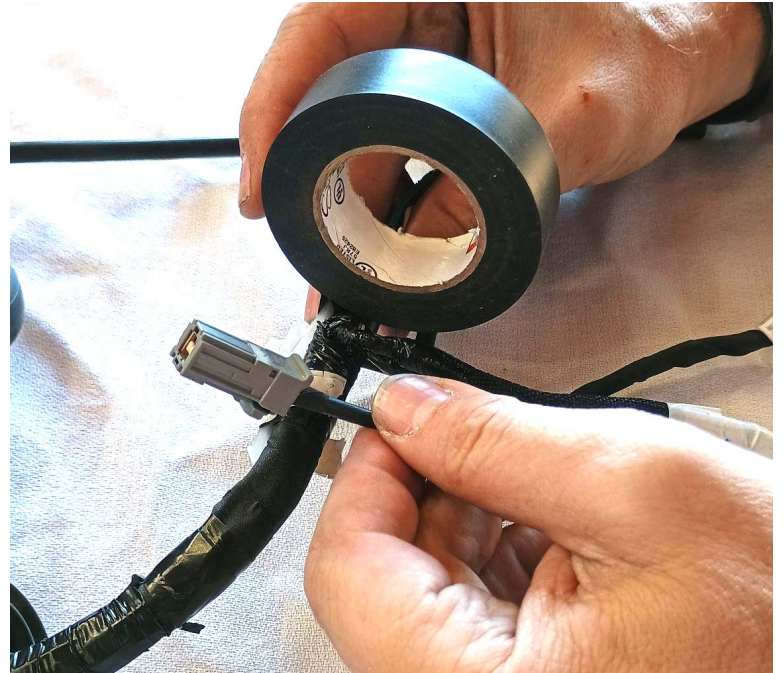
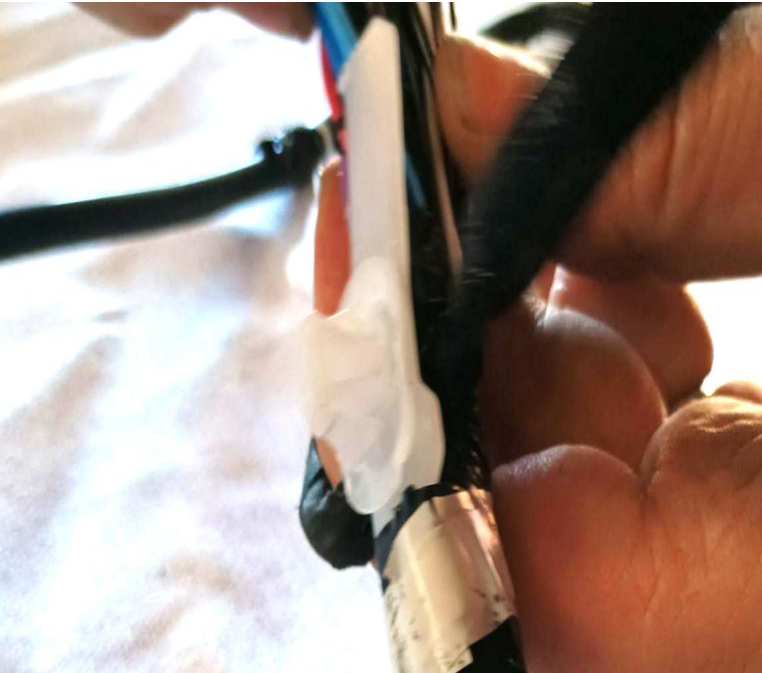
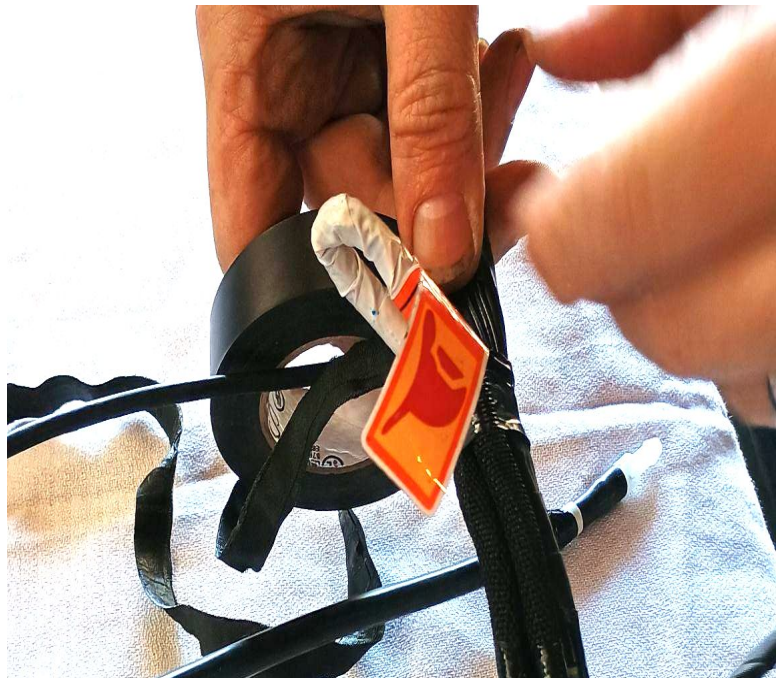
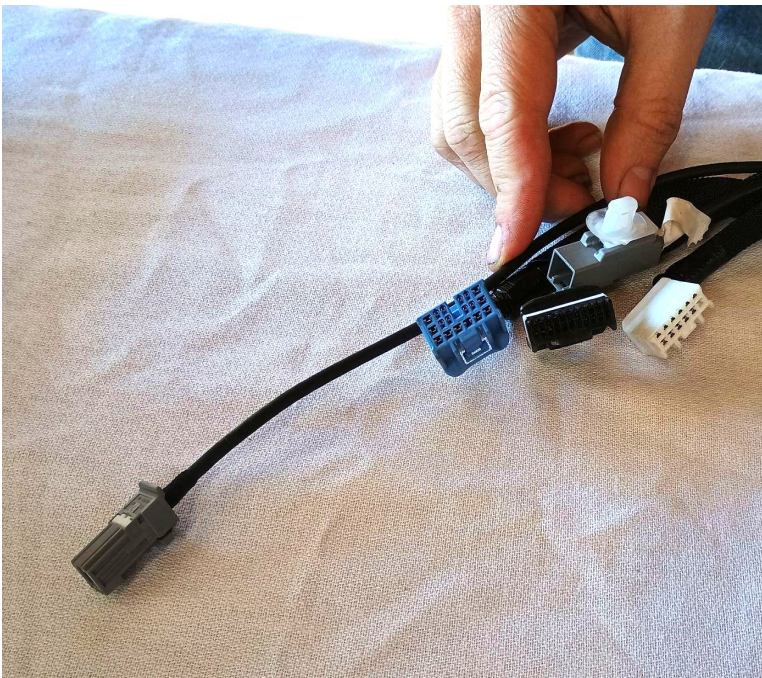

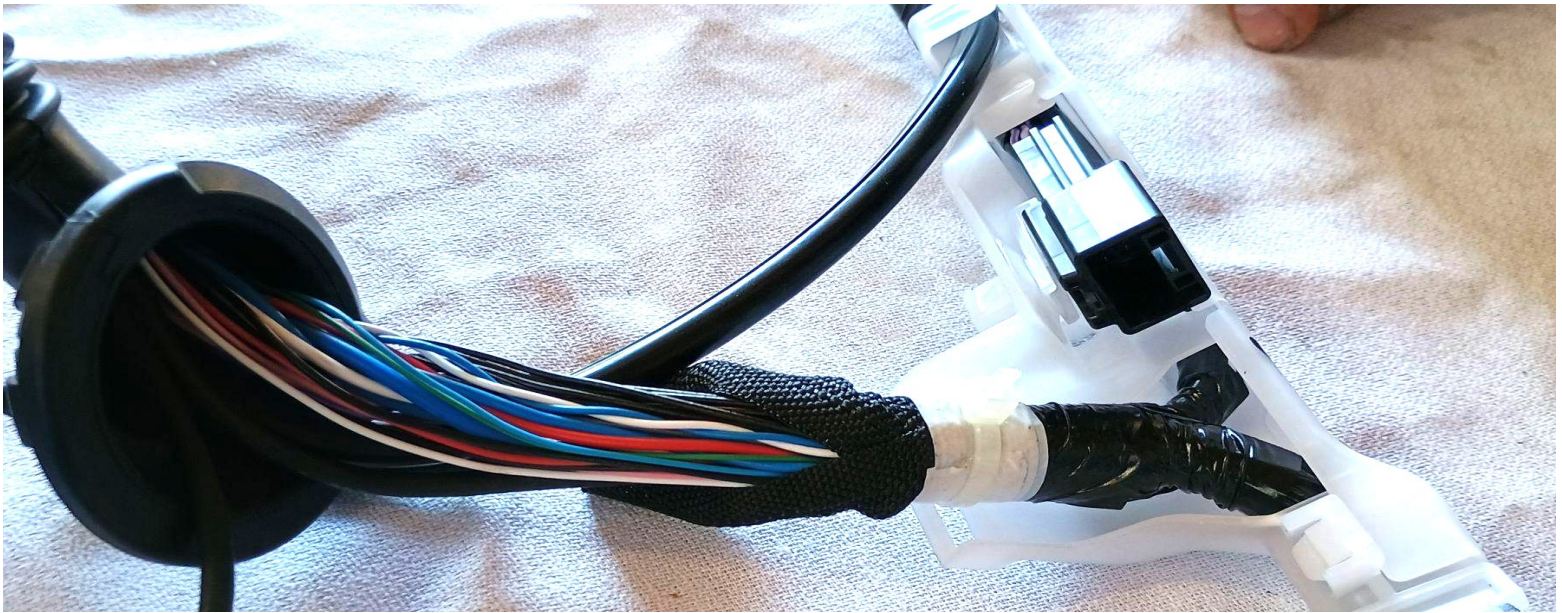
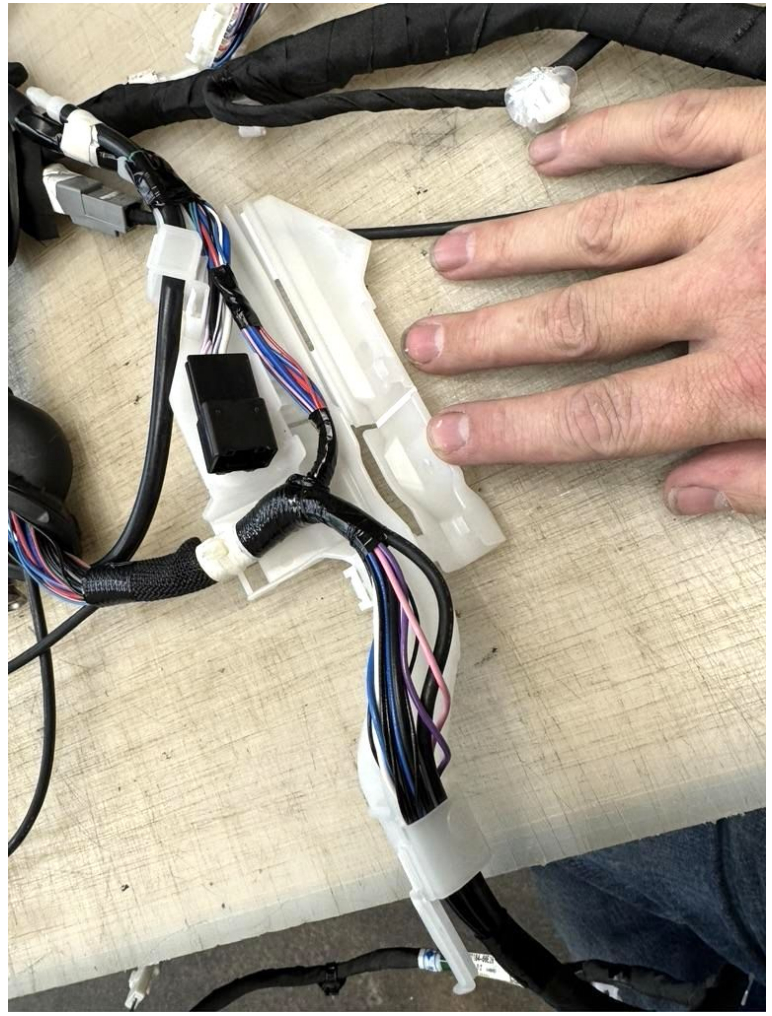
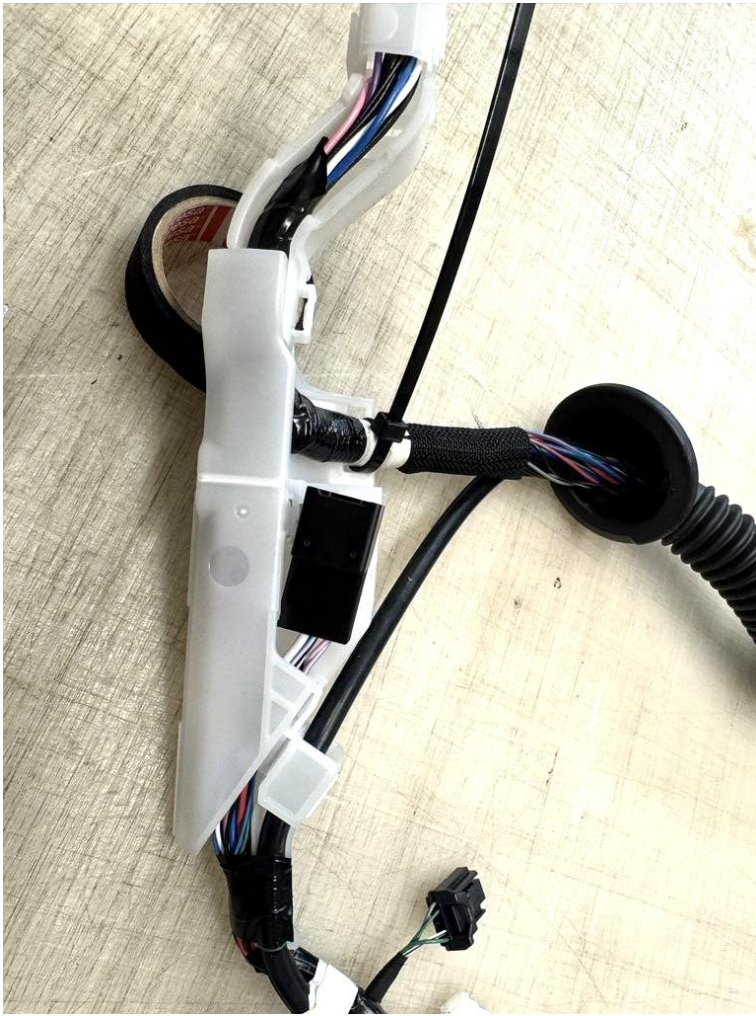

9 – COMPLETE LOOM REINSTALLATION

Reinstall the harness (reverse or step 6) and plug everything back in to test and verify that everything has been returned to its original location. Make sure everything is working including the camera. Refer to your own notes as reference. Disconnect the camera and hose to resume the installation.

RESUME EASY METHOD - CONTINUE EXTENSION CABLE METHOD

10 – CAMERA PASS THROUGH

Remove and file down the housing opening to fit the provided clamp block. Reinstall and insert the camera wire and extended hose tubing through. Wrap and reloom any wiring past this point. Reinstall the original location.

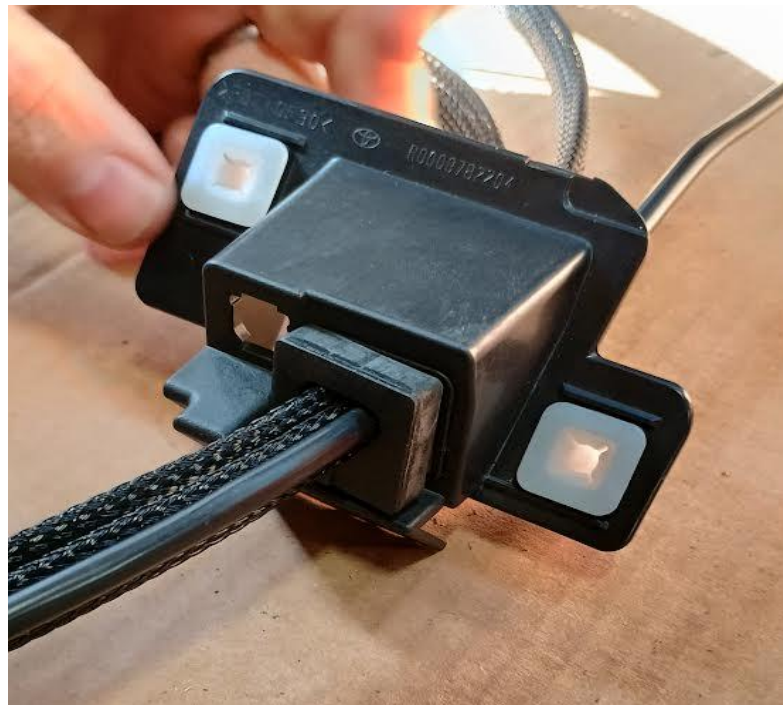

11 - CAMERA BASE INSTALLATION

Mount the camera housing assembly on the back door using the provided hardware and spacers. This will require drilling through the back door. From the top 2 OEM hole locations, mark 2 additional mounting holes between 5'-5.5" directly below the oem holes. Drill for either a 1/4" bolt size opening if mounting with nylocs or 3/8" / slightly smaller opening if using the riv nuts. Cover any drilled locations to prevent rust. Mount the base plate with the provided M6 and 1/4" hardware per choice above. Use the circular spaces and rubber washer to space away from the door as needed. Use the rubber washer to help hold in place while mounting. Without fully closing the door (or reconnect the door buttons),

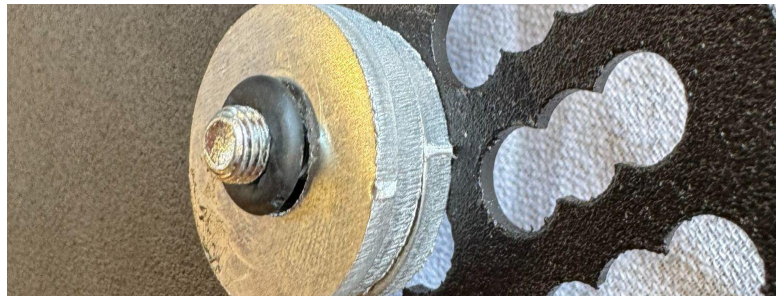

12 - LICENSE PLATE LIGHT WIRING

Remove the OEM license plate lights. Using a reader, find and splice the power to the provided red connectors. Splice and extend if needed the provided lights. Wrap and loom wires with the provided cover and extend through the original light openings. Insert lights into base plate.



13 – BASE PLATE HARDWARE

Install clip nuts onto base plate.

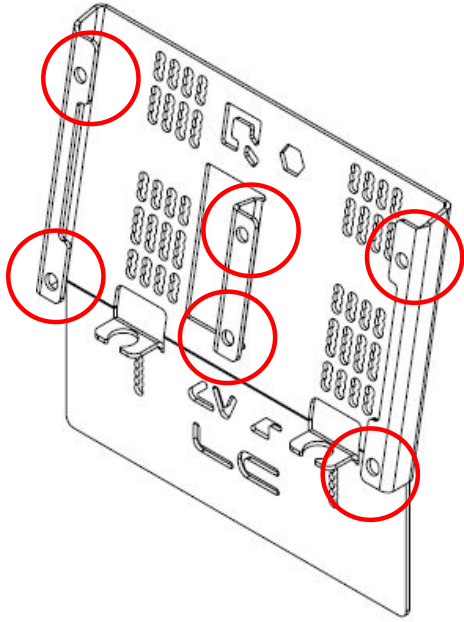

14 - COVER ASSEMBLY

Mount the cover top to the desired side. Rotate into place by inserting the tabs into the matching openings. Lock into place by pressing down with the provided clip on the back side and bending the center tab. Mount the cap to the other side. Rotate into place at the top edge. Lock into place on the back side by inserting the tabs as shown on each side.

Double check the position of the cover extension in relation to the arms and any added accessories.

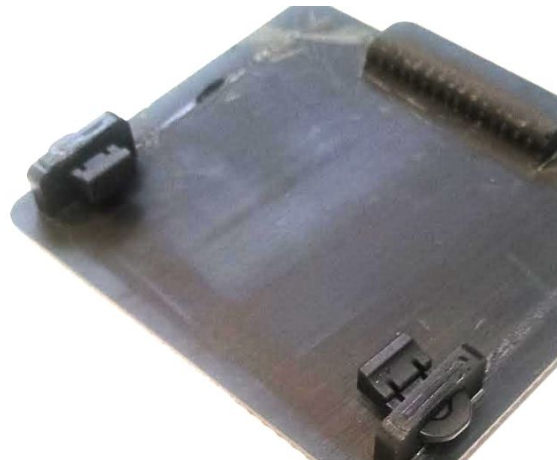
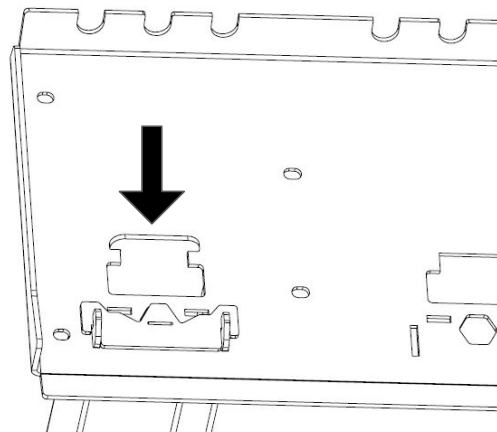
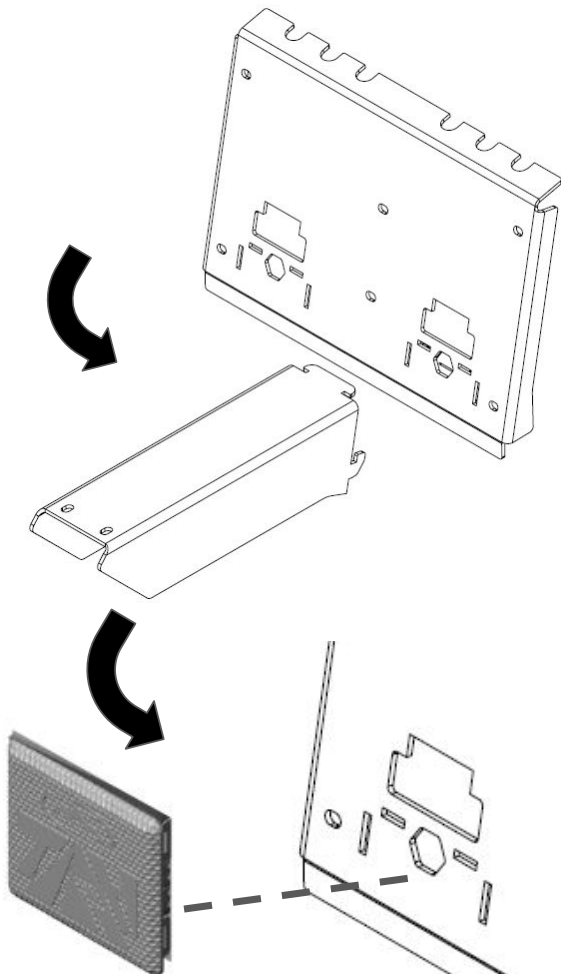

15 – COVER INSTALLATION

Mount the cover using the provided 1/4" hardware. Ensure the camera looms and hose are passed through the opening and no pinching occurs.

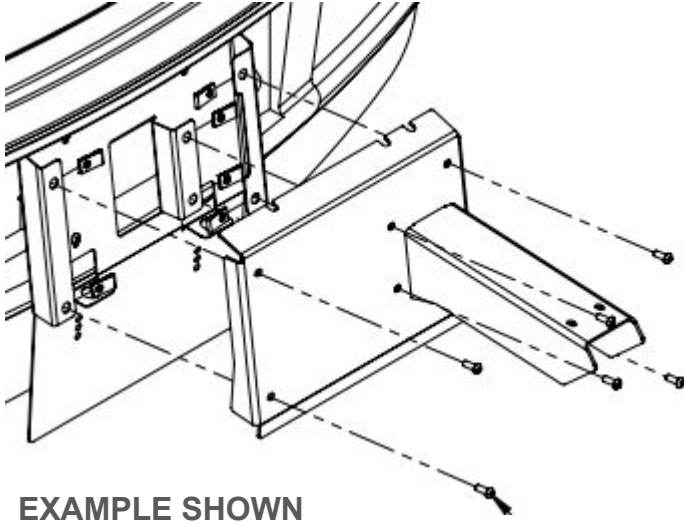

EXAMPLE SHOWN



16 – CAMERA AND WASHER INSTALLATION

Insert the camera into the provided mount and install using the OEM hardware. DOUBLE check it is upright. Repeat the same process for the washer end. Next mount the assembly onto the cover bottom using the provided 1/4" hardware. Adjust as needed.



17 – COVER BOTTOM INSTALLATION

Attach the provided clip nuts to the top of the cover. Mount the bottom into the extension, ensure the camera looms and hose are clear and no pinching occurs

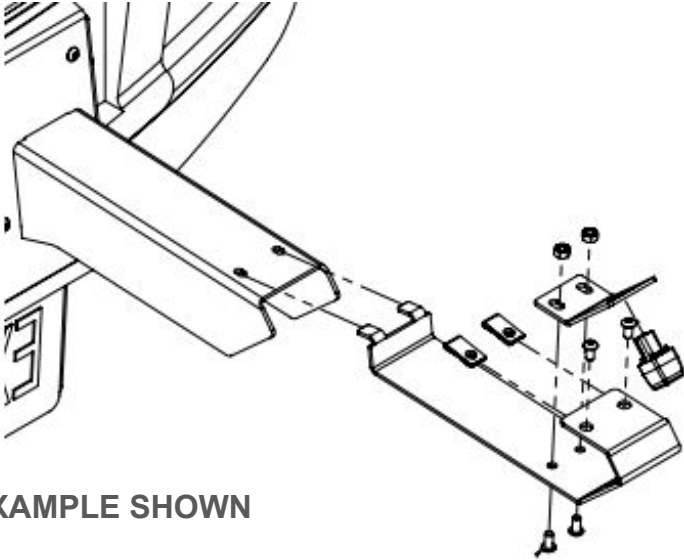

EXAMPLE SHOWN



18 – REAR DOOR PANEL INSTALLATION

Verify everything is working and reinstall all rear door and interior panel pieces.

TIGHTEN ALL HARDWARE AFTER EVERYTHING IS INSTALLED ON THE VEHICLE. CHECK AND RETIGHTEN ALL HARDWARE AFTER THE FIRST 100 MILES AND AFTER OFF ROADING. CHECK REGULARLY AFTER EXTENDED OFFROAD USE